

Accuphase

STEREO POWER AMPLIFIER

P-650

- Powerful 6-parallel push-pull output stage delivers linear power into ultra-low impedance loads
- Current feedback guarantees great sound and stable operation
- Bridged connection mode allows upgrading to true monophonic amplifier
- Printed circuit boards made from Teflon material
- Massive Super Ring toroidal transformer rated for 1 KVA

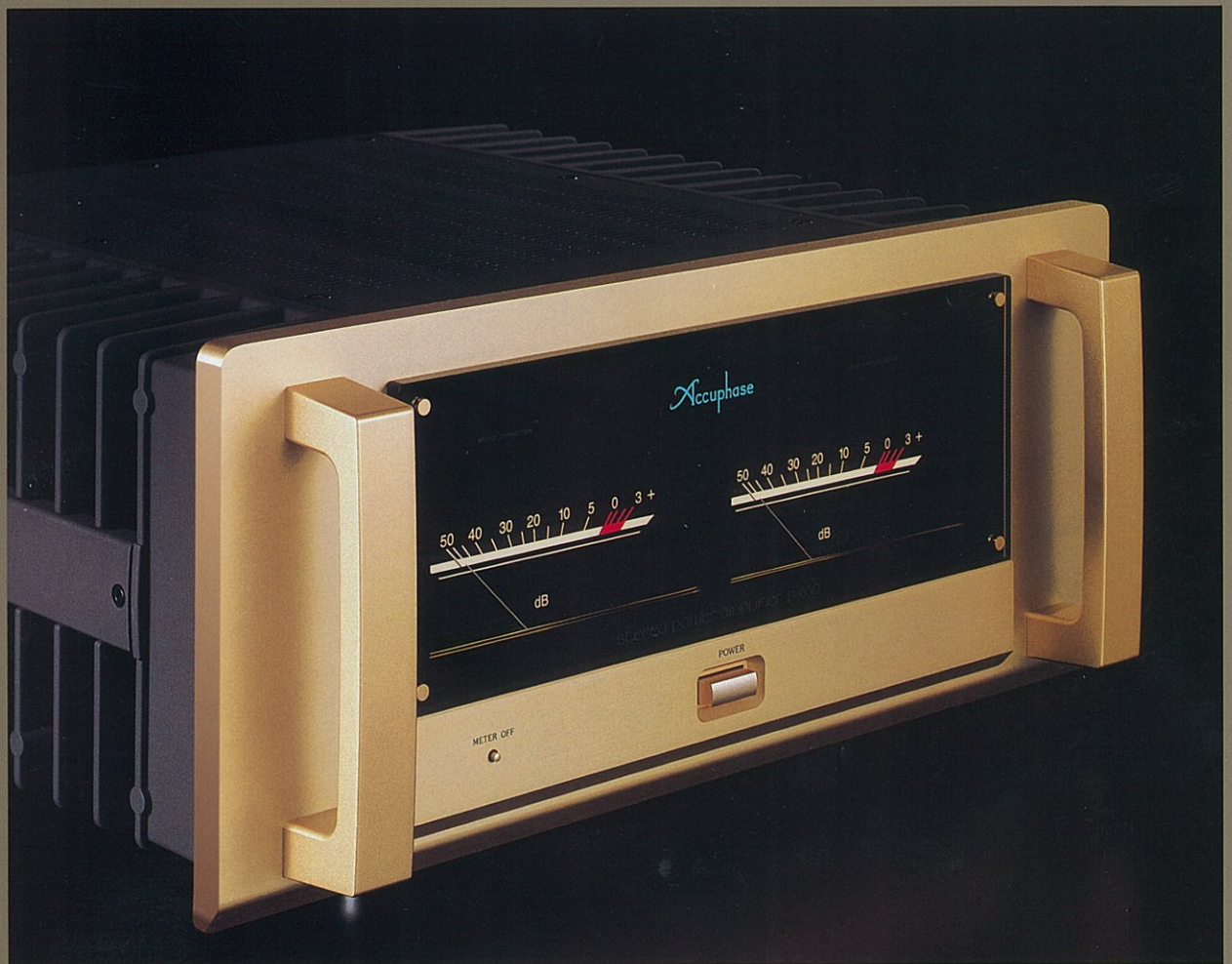

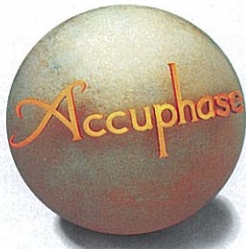

Astounding energy emerging from perfect poise – witness a stereo power amplifier capable of delivering 720 watts (actual measurement) into 1-ohm loads. Massive power supply with 1000 VA toroidal transformer and wide-band high-power transistors in 6-parallel push-pull configuration ensure constant-voltage drive. Teflon printed circuit boards feature low dielectric constant and low loss. Current feedback topology guarantees stable operation up to ultra high frequencies.

Accuphase power amplifiers are designed to realize two major goals: very low output impedance (Note 1), and constant drive voltage (Note 2). As a result, Accuphase amplifiers are capable of driving any kind of speaker load with optimum results, which is one of the reasons behind the high praise that these products invariably receive. The low impedance not only ensures accurate speaker drive but also absorbs the counterelectromotive force generated by the voice coil, thereby eliminating a major source of intermodulation distortion. The overall result is a significant improvement in sound quality.

The P-650 is a stereo power amplifier which fully implements these advanced circuit design principles. Using only strictly selected high-quality parts, this product was designed with a full mastery of all aspects of amplifier performance. The output uses six pairs of high-power transistors in each channel, arranged in a parallel push-pull configuration. These devices are mounted to massive heat sinks located on both sides of the unit, for efficient dissipation of thermal energy. Power linearity is maintained down to extremely low load impedances. This allows the amplifier to easily drive even speakers with very low impedance or uneven impedance curves. By using the P-650 in bridged mode, you can create a mono amplifier with even more impressive power reserves.

Current feedback topology combines total operation stability with excellent frequency response, while requiring only minimal amounts of negative feedback. The printed circuit boards of the P-650 are made of a Teflon material with extremely low dielectric constant and low loss, resulting in more transparent sound. The front panel in traditional champagne gold features two large analog power meters. The elegant and sophisticated appearance of the amplifier will enhance every listening room.

Note 1: Low amplifier output impedance

The load of a power amplifier, namely the loudspeaker generates a counterelectromotive force that can flow back into the amplifier via the NF loop. This phenomenon is influenced by fluctuations in speaker impedance, and interferes with the drive performance of the amplifier. The output impedance of a power amplifier should therefore be made as low as possible by using output devices with high current capability.

Note 2: Constant drive voltage principle

Even in the presence of a load with wildly fluctuating impedance, the ideal power amplifier should deliver a constant voltage signal to the load. When the supplied voltage remains constant for any impedance, output power will be inversely proportional to the impedance of the load. A conventional amplifier can be easily made to operate in this way down to a load impedance of about 4 ohms. However, at 2 ohms and below, much more substantial output reserves are needed, which can only be sustained by an extremely well designed and capable output stage and a highly robust and powerful power supply section. To build such an amplifier is a task that requires not only considerable experience and resources but also a thorough reappraisal of basic tenets.

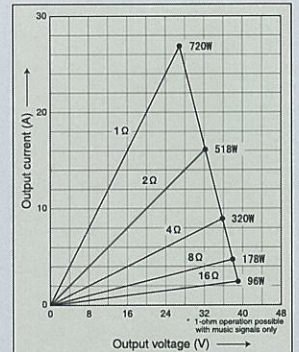

Figure 2 Load impedance vs. output power (output voltage/output current) of P-650

Power units with 6-parallel push-pull configuration deliver ample linear power: 400 watts into 2 ohms, 200 watts into 4 ohms, or 100 watts into 8 ohms

The output stage uses high power transistors with excellent linearity and switching characteristics, rated for a collector dissipation of 130 watts and collector current of 15 amperes. These transistors are arranged in a 6-parallel push-pull configuration (Figure 1) and mounted on massive heat sinks made from diecast aluminum, for efficient heat dissipation. This enables the P-650 to effortlessly drive even speakers with extremely low impedance or with reactive loads.

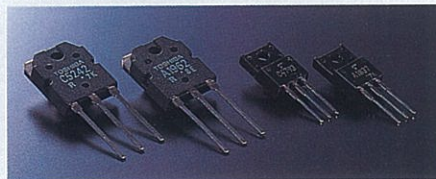

Figure 2 shows the output/voltage characteristics at various load impedances. It can be seen that output voltage remains nearly constant regardless

of load, which means that output current increases linearly. The actually measured clipping power is an impressive 720 watts into 1 ohm, 518 watts into 2 ohms, 320 watts into 4 ohms, or 178 watts into 8 ohms.

Current feedback circuit topology prevents phase shifts

The P-650 employs the so-called current feedback principle. Figure 3 shows the operating principle of this circuit. At the sensing point of the feedback loop, the impedance is kept low and current

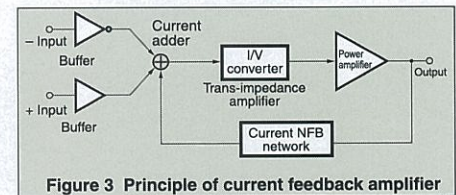

Figure 3 Principle of current feedback amplifier

detection is performed. An impedance-converting amplifier then converts the current into a voltage to be used as the feedback signal. Since the impedance at the current feedback point (current adder in Figure 3) is very low, there is almost no phase shift. Phase compensation can be kept to a minimum, resulting in excellent transient response and superb sonic transparency. Figure 4 shows frequency response for different gain settings of the current feedback amplifier. The graphs demonstrate that response remains uniform over a wide range.

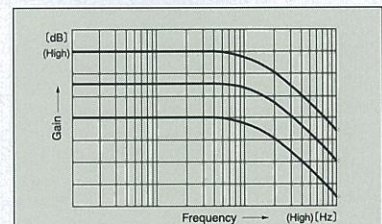

Fig. 4 Frequency response with current feedback (response remains uniform also when gain changes)

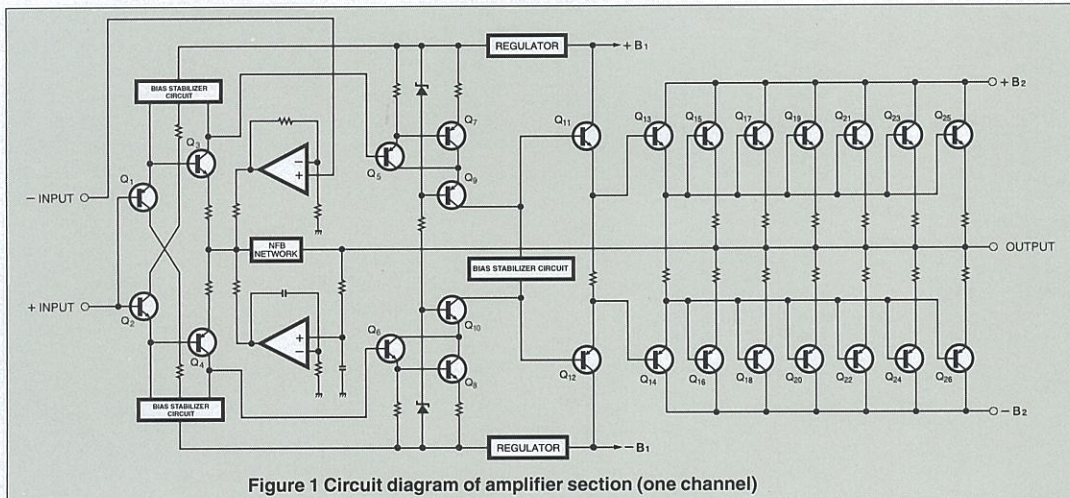

Figure 1 Circuit diagram of amplifier section (one channel)

Bridged mode creates a true monophonic amplifier with 800 watts into 4 ohms or 400 watts into 8 ohms

Bridged operation means that two amplifiers are driven by the same signal voltage but with opposite phase. The P-650 provides a switch arrangement for bridged operation of its two channels, which turns the unit into a high-grade monaural amplifier with even higher output capability.

Easy switching between dual mono operation and bridged connection

A mode selector on the rear panel makes it simple to switch between dual mono, stereo, or bridged operation. The dual mono position is useful for example to drive a center woofer in mono, or to obtain the same signal from both speaker outputs for driving a bi-amped speaker setup.



Printed circuit boards made from Teflon material (glass cloth fluorocarbon resin) with low dielectric constant and low loss

The power amplification circuit boards are made of a glass cloth fluorocarbon resin material which has a stable, low dielectric constant as well as superior heat resistance and high-frequency characteristics. The low dielectric constant

minimizes leak currents between patterns and results in more speedy signal propagation. Low losses mean further enhanced signal purity. S/N ratio also is excellent.

* Teflon is a registered trademark of DuPont USA.

Balanced connection reliably blocks induced noise

Balanced signal transmission means that two signal lines are used which carry the same signal with opposite phase. On the receiving side, the signals are mixed. Since any noise interference that has arisen during transmission will be present in

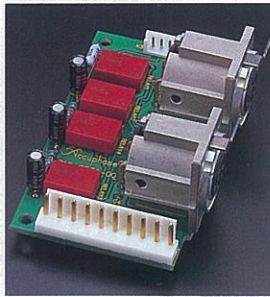

both lines with identical phase, such noise is canceled out, leaving only the pure original signal. Balanced connection therefore keeps the signal transfer free from any kind of interference.

All major signal paths gold-plated

The P-650 uses gold-plating for the copper traces on printed circuit boards as well as for ground bars carrying large ripple currents, bus bars providing current to the power transistors, input jacks, and speaker terminals. This thorough approach results in a distinct sonic improvement.

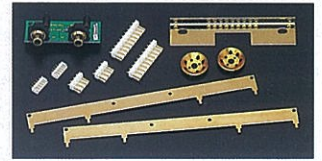

Robust power supply with "Super Ring" toroidal transformer and high filtering capacity

The P-650 features a large toroidal power transformer with a rating of about 1 kVA. Toroidal

6-parallel push-pull output stage with transistors mounted directly to large aluminum diecast heat sinks. Power amplifier assembly with Teflon PCBs and current feedback amplifier circuitry.



power transformers use heavy-gauge copper wiring on a doughnut-shaped core. This results in low impedance and high efficiency, while allowing compact dimensions. In particular, the "Super Ring" transformer used in the P-650 has various advantages, such as the near-circular core caliber, allowing near-

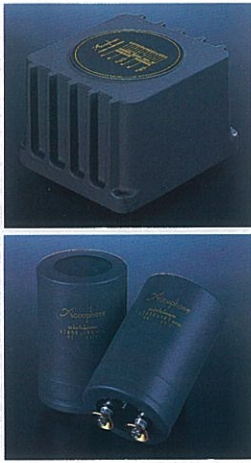

circular coil windings with high packing density. Two ultra-large aluminum electrolytic capacitors rated for 47,000 μ F each serve to smooth the pulsating direct current from the rectifier, providing more than ample filtering capacity.

Extra large speaker terminals

The oversize speaker terminals accept also very heavy-gauge speaker cable. The terminals are made of extruded high-purity brass material and are gold-plated for utmost reliability and minimum contact resistance. Molded caps provide proper insulation.



Large direct-reading analog power meters

The large analog power meters cover a wide dynamic range and provide direct readings. Switches for meter on/off and illumination control are also provided.

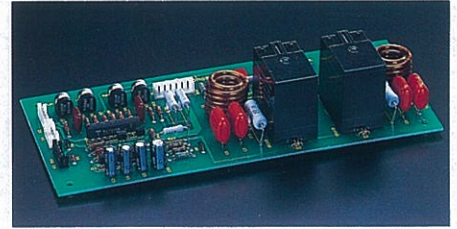

Assembly with protection circuitry, etc.

FRONT PANEL

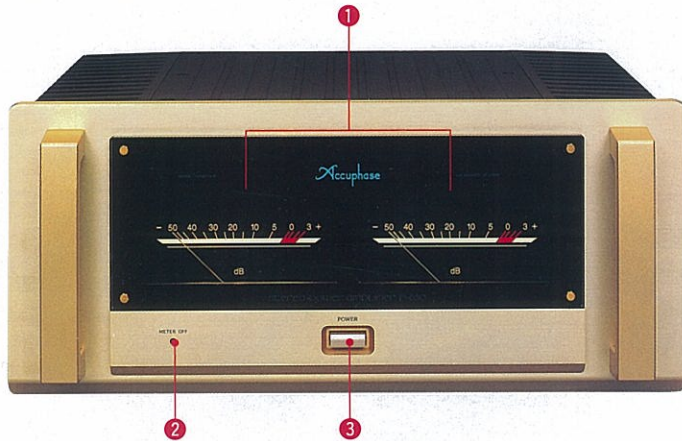

REAR PANEL

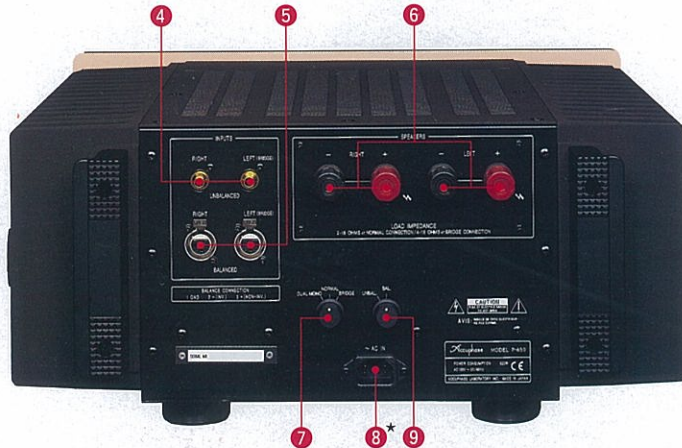

- | | |
|--|---|
| 1 Power meters for left and right channel (dB scale) | 6 Speaker output terminals for left and right channel |
| 2 Meter operation/illumination switch ON OFF | 7 Mode selector DUAL MONO NORMAL BRIDGE |
| 3 Power switch | 8 AC input connector (for supplied power cord)* |
| 4 Unbalanced inputs | 9 Input selector UNBAL BAL |
| 5 Balanced input connectors | |
| 1 Ground 2 Inverted (-) | |
| 3 Non-inverted (+) | |

Remarks

- * This product is available in versions for 120/230 V AC. Make sure that the voltage shown on the rear panel matches the AC line voltage in your area.
- * The shape of the AC inlet and plug of the supplied power cord depends on the voltage rating and destination country.

* Specifications and design subject to change without notice for improvements.

P-650 Guaranteed Specifications

(Guaranteed specifications are measured according to EIA standard RS-490.)

- **Continuous Average Output (20 to 20,000 Hz)**

Stereo mode	650 watts per channel into 1 ohms*
(both channels driven)	400 watts per channel into 2 ohms
	200 watts per channel into 4 ohms
	100 watts per channel into 8 ohms

Note: Ratings marked * are for music signals only.

Monophonic mode	1,300 watts into 2 ohms*
(bridge connection)	800 watts into 4 ohms
	400 watts into 8 ohms

Note: Ratings marked * are for music signals only.
- **Total Harmonic Distortion**

Stereo mode (both channels driven)	0.05% with 2-ohm load
	0.02% with 4- to 16-ohm load
Monophonic operation (bridged connection)	0.02% with 4- to 16-ohm load
- **Intermodulation Distortion** 0.003%
- **Frequency Response**

At rated output:	20 - 20,000 Hz +0, -0.2 dB
At 1 watt output:	0.5 - 160,000 Hz +0, -3.0 dB
- **Gain** 28.0 dB (in stereo and monophonic operation)
- **Output Load Impedance**

Stereo operation:	2 to 16 ohms
Monophonic operation:	4 to 16 ohms

* With music signals, load impedance of 1 ohm (stereo) or 2 ohms (mono) can be driven.
- **Damping Factor** 270 (stereo/monophonic operation)
- **Input Sensitivity (with an 8-ohm load)**

Stereo mode	1.12 V for rated output
	0.11 V for 1 watt output
Monophonic mode	2.25 V for rated output
	0.11 V for 1 watt output
- **Input Impedance**

Balanced:	40 kilohms
Unbalanced:	20 kilohms
- **Signal-to-Noise Ratio (A-weighted, input shorted)** 120 dB (rated continuous average output)
- **Output Level Meters** -50 dB to +3 dB, logarithmic scale, OFF switch provided
- **Power Requirements** 120V/230V (Voltage as indicated on rear panel) AC, 50/60Hz
- **Power Consumption**

80 watts idle
625 watts in accordance with IEC-65
- **Maximum Dimensions**

Width:	475 mm (18-11/16")
Height:	223 mm (8-3/4")
Depth:	491 mm (16-1/2")
- **Weight**

38 kg (83.8 lbs.) net
48 kg (105.8 lbs.) in shipping carton.